

UŠĆE TOWER ONE

PRIRUČNIK ZA OZNAČAVANJE



01 VIZUELNI PRAVAC

02 GRAFIČKI ELEMENTI

03 POZICIJE



VIZUELNI PRAVAC

01



Glavni motiv je apstraktna geometrijska reprezentacija lokacije Ušće, akcentat je na iznajmljivanju kancelarija / office space.

Pozicioniranje linija asocira na neograničene mogućnosti (linije idu u margo, odnosno nisu sputane).

Dominantna crna boja sugerise ekskluzivnost, svetlo plava kao akcent boja - biznis i upotrebu novih tehnologija/modernog poslovnog okruženja.

Suptilna asocijacija na ćiriličko slovo Y.

Dizajn je modularan, te se može lako primentiti i uklopiti u raznim situacijama/proporcijama (kvadratni, portrait, landscape).

Ušće
Office space for rent
Luxury (black)
Trusted (blue)











GRAFIČKI ELEMENTI

TIPOGRAFIJA

PIKTOGRAMI

BOJE

02

TIPOGRAFIJA

AKROBAT

GOTHAM

Akrobat

Akrobat is a modern sans serif font with condensed proportions. The typeface comes in 8 weights with a geometric aesthetics and slight neo-grotesque characteristic. It's narrow proportions makes it perfect for headlines, logos, signage, typographic compositions and short paragraphs of text. Acrobat contains more than 500 glyphs with a wide range of languages - extended Latin and Cyrillic character support as well as Bulgarian localization features.

<https://www.fontfabric.com/fonts/akrobat/>

DESIGNERS MUST NOT
emphasise design elements over content
Good Design
is as little design as
POSSIBLE
Dieter Rams

AKROBAT LIGHT

AaBbCcDdEeFfGgHhIiJjKkLlMmNnOoPpQqRrSsTtUuVvWwXxYyZz
0123456789 !"#\$%&/()=?*{}:"<>?\[;',./

AKROBAT REGULAR

AaBbCcDdEeFfGgHhIiJjKkLlMmNnOoPpQqRrSsTtUuVvWwXxYyZz
0123456789 !"#\$%&/()=?*{}:"<>?\[;',./

AKROBAT BOLD

AaBbCcDdEeFfGgHhIiJjKkLlMmNnOoPpQqRrSsTtUuVvWwXxYyZz
0123456789 !"#\$%&/()=?*{}:"<>?\[;',./

AKROBAT BLACK

AaBbCcDdEeFfGgHhIiJjKkLlMmNnOoPpQqRrSsTtUuVvWwXxYyZz
0123456789 !"#\$%&/()=?*{}:"<>?\[;',./

Latin Alphabet

Aa Bb Cc Dd Ee Ff Gg Hh
Ii Jj Kk Ll Mm Nn Oo Pp Qq
Rr Ss Tt Uu Vv Ww Xx Yy Zz

0 1 2 3 4 5 6 7 8 9 0

+ Extended Latin
language support

Mütþjínǵúǎ!

Cyrillic Language Support

Аа Бб Вв Гг Дд Ее Ёё Жж Зз
Ии Йй Кк Лл Мм Нн Оо Пп Рр
Сс Тт Уу Фф Хх Чч Цц Шш
Щщ Ъъ Ыы Ээ Юю Яя

Gotham

The bold architectural capitals that inspired the iconic Gotham typeface are merely the cornerstone of a versatile family of fonts. Four different widths in a range of weights, plus deep character sets, extended language support, and versions for different media, combine to make Gotham a powerful and indispensable design.

<https://www.typography.com/fonts/gotham/>

GOTHAM REGULAR

AaBbCcDdEeFfGgHhIiJjKkLlMmNnOoPpQqRrSsTtUuVvWwXxYyZz
0123456789 !"#%&/()=?*{}:"<>?\[;',./

GOTHAM BOLD

AaBbCcDdEeFfGgHhIiJjKkLlMmNnOoPpQqRrSsTtUuVvWwXxYyZz
0123456789 !"#%&/()=?*{}:"<>?\[;',./

GOTHAM BLACK

AaBbCcDdEeFfGgHhIiJjKkLlMmNnOoPpQqRrSsTtUuVvWwXxYyZz
0123456789 !"#%&/()=?*{}:"<>?\[;',./

PIKTOGRAMI

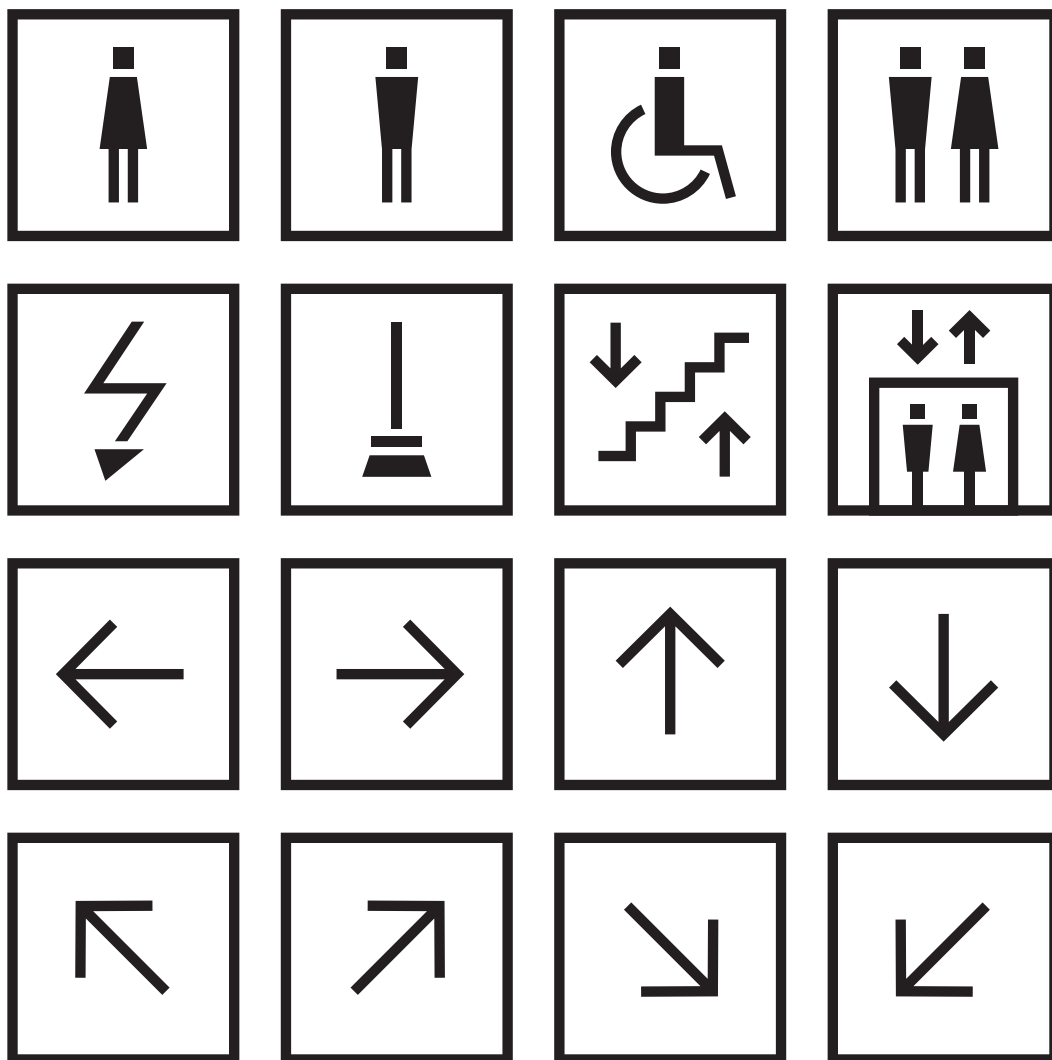

Dimenzije: 150x150mm

Stil: monoline

Debljina linije: 7mm

Materijal: Crni klirit 3mm

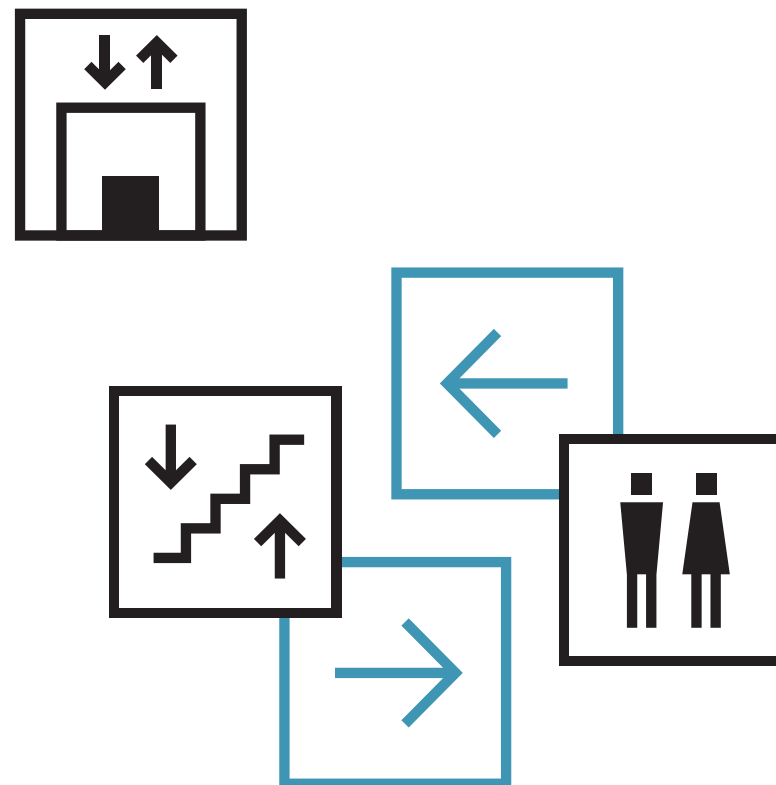



BOJE

PRIMARNA BOJA



Crna

k 100%

RAL 9005 Jet black

#000000

AKCENT BOJA



PANTONE 7459c

C70 M25 Y20 K10

RAL 5018 Turquoise blue

#448ea8

POZICIJE

LOBI PRIZEMLJE
LIFT LOBI

03

LOBI PRIZEMLJE

INFO EKTRAN

RECEPCIJA

TOTEMI

HIDRANT

OZNAKE/ZABRANE

UŠĆE TOWER ONE				
GF	Addiko Bank	Corner Shop	Addiko Bank AD Corner Shop d.o.o.	
01	02	03	Addiko Bank Addiko Bank AD	
04	BALKANS REAL ESTATE	CONFLUENCE PROPERTY MANAGEMENT	Balkans Real Estate d.o.o. Confluence Property Management d.o.o.	
05	06	07	08	IGT IGT Global Services Limited d.o.o. Ogranak Beograd
10	ADAMA	HTR REFRACOTORIES	MERKUR OSIGURANJE Adama SRB d.o.o. HTR Refractories d.o.o. Merkur Osiguranje ADO	
11	privax	avast	Privax d.o.o.	
12	Romčević LAW OFFICE	privax	Advokat Katarina P. Romčević	
	DELL Technologies	avast	Predstavništvo EMC computers systems Privax d.o.o.	

UŠĆE TOWER ONE			
13	BORA SPORT FITNESS TRAINING	Evernon d.o.o.	Bora Sport d.o.o. CSA Mode RS d.o.o. Evernon d.o.o.
	CSA FITNESS TRAINING	Laboratorija BEOGRAD	Preduzeće za spoljnu i unutrašnju trgovinu Laboratorija doo
14	Comita OGRAKAK COMITA BEOGRAD		Comita d.d. Ogranak Comita Beograd
15	apcom	GE	Apcom Distribution d.o.o. Apo Plus d.o.o. Beograd
	APD PLUS d.o.o.	Ofika	Arneg S.P.A. Predstavništvo Beograd
	ANEE BEOGRAD	ΦOCATPO	Deichmann Trgovina Obucem SRB doo
	D	SECUTi	Ogranak GE Electric International Inc. Ofika Group doo
			Phosagro Balkans d.o.o. Secut d.o.o.
16	Akton communications	IQVIA IQVIA Health & Quantiles are now	Akton d.o.o. Apcom Distribution d.o.o.
	apcom	WORLDWIDE INSPECTIONS	East Side Financial Advisory d.o.o.
	ESFA		Predstavništvo IQVIA AG Worldwide d.o.o.
17	GE	ΦOCATPO	GE Holdings d.o.o.
	JICA	VEGAI	Kancelarija Japansko Agencije za međunarodnu saradnju Jica
			Phosagro Balkans d.o.o. Doo Vega It Sourcing

UŠĆE TOWER ONE			
18	WOLF THEISS		Wolf Theiss d.o.o.
19	Regus		SEE Business Embassies d.o.o.
20	IBM		IBM International
21	3QP	SIXSENTIX Accelerate Quality	JAP d.o.o.
		OACube Accelerated Reporting	Sixsentix d.o.o.
22	emric A Smoother Credit Journey		Emric d.o.o.
23	MPC HOLDING	CONFLUENCE PROPERTY MANAGEMENT	MPC Holding d.o.o. Confluence Property Management d.o.o.
24	HS HARRISONS		Advokat Mark William Harrison
25	Top of the Hub		Beangpot Beograd d.o.o.



DIMENZIJE: 210X105cm, DUBINA SLOVA 40mm



MATERIJAL: brušeni inoks



DIMENZIJE:
368.5mm x 110mm

MATERIJAL:
Klirit - mat crni 3mm, direktna UV štampa
Klirit - providni 2mm

210mm

368.5mm

297.5

110mm

71.5mm

PRAVILA O PRISTUPU POSEILACA U PC UŠĆE ("PRAVILA")

1. **Pravila PC Ušće**
Pravila u PC Ušće su to da i dalje ne smete koristiti kompjuterske sisteme pri pristupu u PC Ušće u ovoj zgradi "Pravila".

2. **Pravila pristupa u PC Ušće**
Pravila pristupa u PC Ušće su to da pristup u PC Ušće možete imati samo u skladu sa pravilima pristupa i pristupom u PC Ušće u skladu sa pravilima pristupa u PC Ušće. Pristup u PC Ušće možete imati samo u skladu sa pravilima pristupa u PC Ušće u skladu sa pravilima pristupa u PC Ušće.

3. **Pravila pristupa u PC Ušće**
Pravila pristupa u PC Ušće su to da pristup u PC Ušće možete imati samo u skladu sa pravilima pristupa u PC Ušće u skladu sa pravilima pristupa u PC Ušće.

4. **Pravila pristupa u PC Ušće**
Pravila pristupa u PC Ušće su to da pristup u PC Ušće možete imati samo u skladu sa pravilima pristupa u PC Ušće u skladu sa pravilima pristupa u PC Ušće.

5. **Pravila pristupa u PC Ušće**
Pravila pristupa u PC Ušće su to da pristup u PC Ušće možete imati samo u skladu sa pravilima pristupa u PC Ušće u skladu sa pravilima pristupa u PC Ušće.

**OBAVEŠTENJE
O OBRADI LIČNIH PODATAKA POSEILACA U PC UŠĆE**

Vaša radnja izdaje lične podatke za pristup karte, uvidanje i uvidanje. Sva oštećenja ličnih podataka je vidljiva evidencija posetilaca su upisane u PC Ušće. Sva oštećenja ličnih podataka je vidljiva evidencija posetilaca su upisane u PC Ušće. Sva oštećenja ličnih podataka je vidljiva evidencija posetilaca su upisane u PC Ušće.

UŠĆE TOWER JE ZGRADA NEPUŠAČKOG TIPA

Ušće Tower je zgrada koja je izgrađena u skladu sa zahtevima EU direktive o zabrani pušenja u javnim prostorima. Ušće Tower je zgrada koja je izgrađena u skladu sa zahtevima EU direktive o zabrani pušenja u javnim prostorima. Ušće Tower je zgrada koja je izgrađena u skladu sa zahtevima EU direktive o zabrani pušenja u javnim prostorima.

PUŠENJE JE ZABRANJENO U SVIM PROSTORIMA ZGRADE

Sprovedeno zabrane pušenja u zajedničkim prostorima zgrade Ušće Tower obuhvata privredno društvo za pružanje usluga sistema obaveštavanja SECURITY d.o.o. Odgovorni nadležnik Ego za sprovede zabrane, koja može tokom dela smene na kartici, zabraniti pušenje.

UŠĆE TOWER IS A NON SMOKING BUILDING

The enforcement of smoking ban in the common areas of Ušće Tower is carried out by the security company SECURITY Ltd. in two shifts by the following employees:

SMOKING IS FORBIDDEN IN ALL AREAS OF THE BUILDING

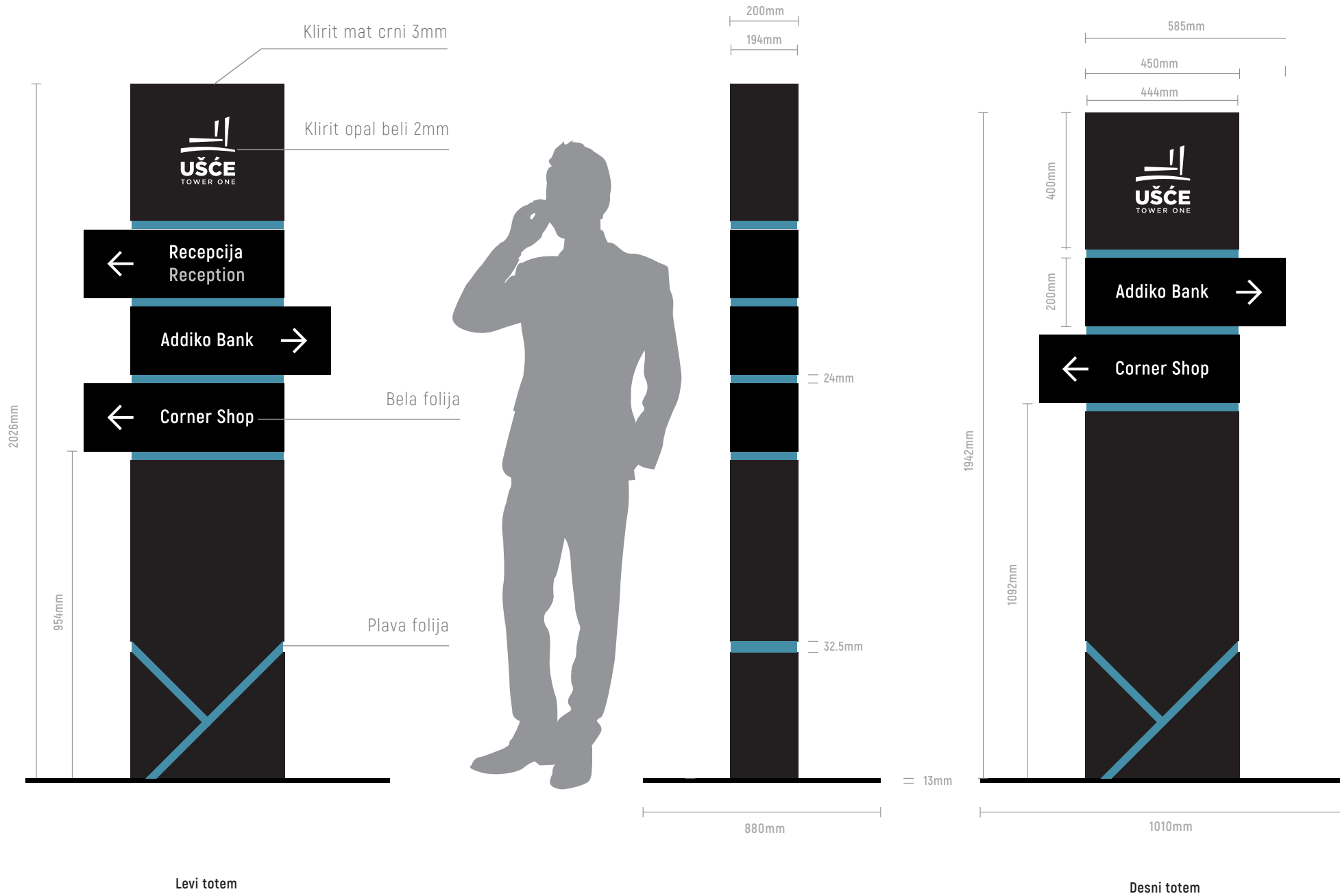

DIMENZIJE: 2026mm x 1010mm x 880mm

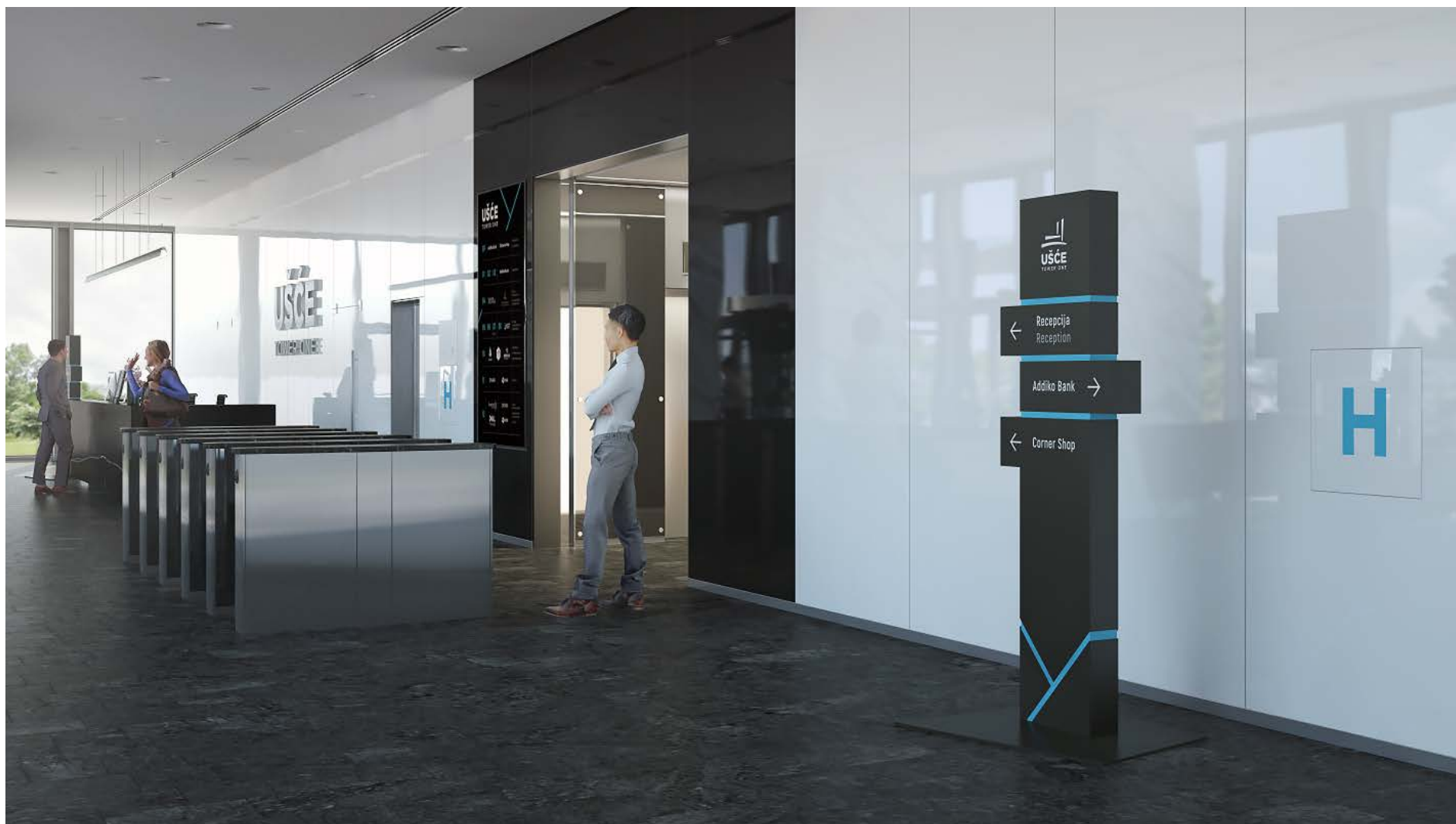

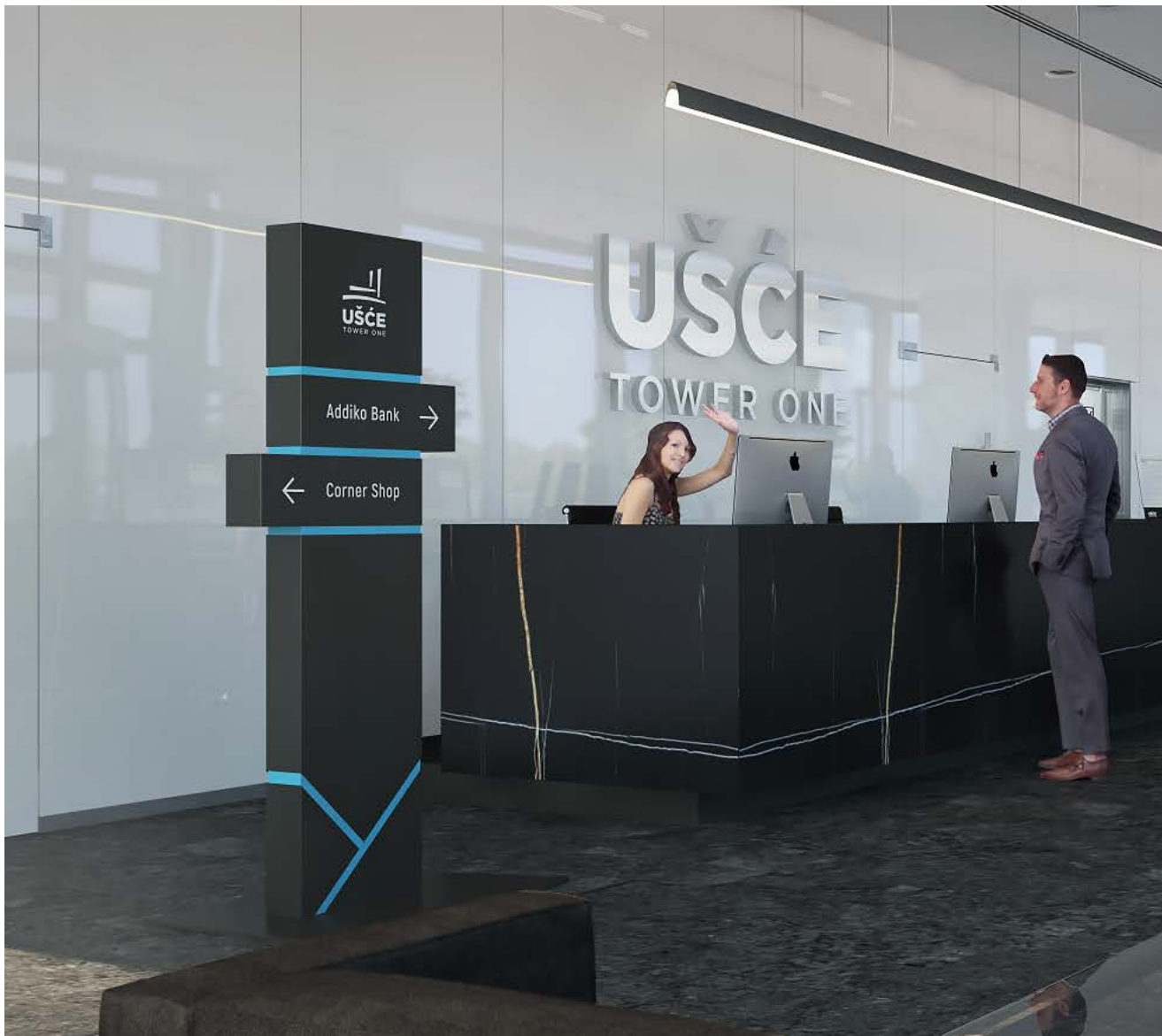

DIMENZIJE:

1942mm x 1010mm x 880mm

MATERIJAL:

Klirit - mat crni 3mm i opal beli 2mm

Bela folija

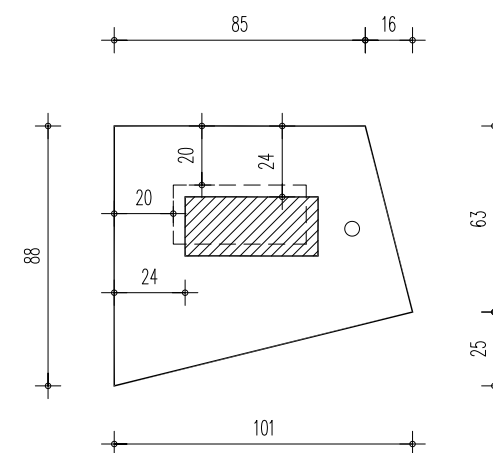

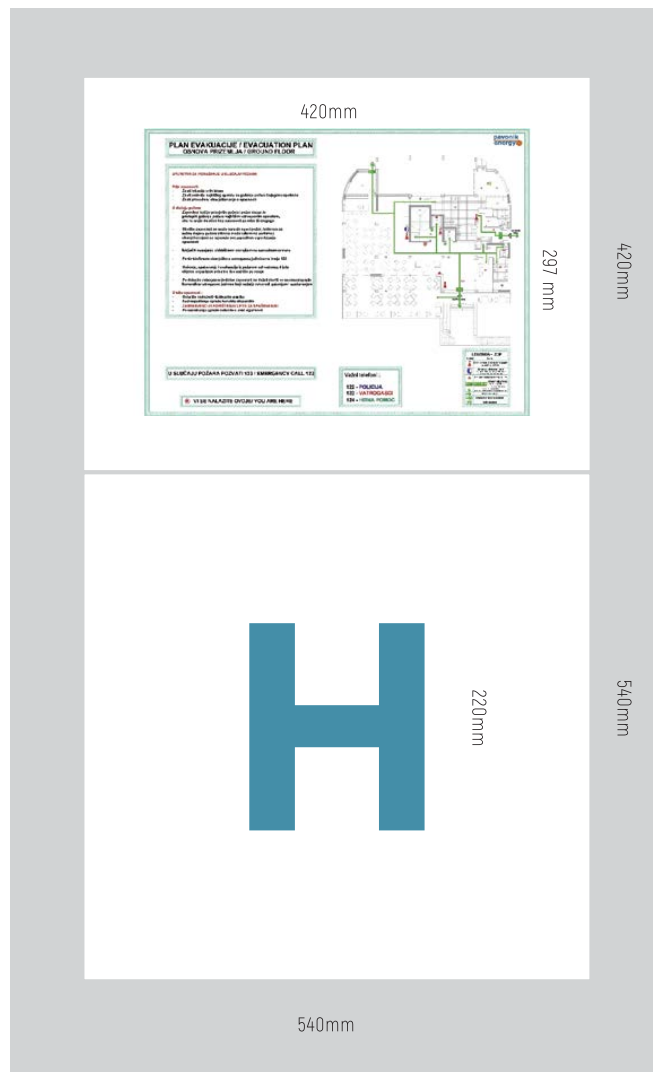
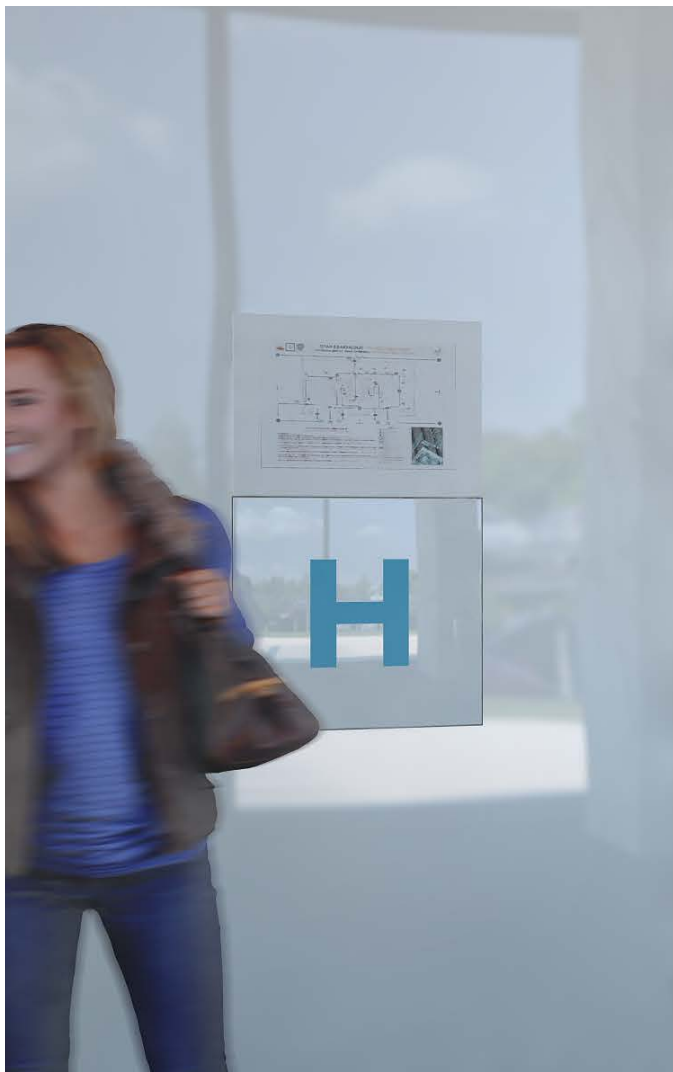

HIDRANT
540X540mm

PLAN EVAKUACIJE
530X420mm
Opal beli klirit 3mm
Direktna UV štampa



PRVI SLOJ
Plava folija

DRUGI SLOJ
Prosečeni klirit
opal beli 3mm

Klirir bel opal 3mm - direktna stampa

210mm

ЗАБРАЊЕНО ПУШЕЊЕ



РЕПУБЛИКА СРБИЈА
МИНИСТАРСТВО ЗДРАВЉА

297mm

ДОЗВОЉЕНО ПУШЕЊЕ



РЕПУБЛИКА СРБИЈА
МИНИСТАРСТВО ЗДРАВЉА

148.5mm

NAZIV PRAVNOG LICA:

ZASTUPNIK PRAVNOG LICA:

15 B
SPRAT STRANA

SECUT d.o.o.
Odgovorno lice za sprovođenje zabrane o pušenju i br. telefona:
MILAN BAŠA
064 875 75 42

DEICHMANN
Odgovorno lice za sprovođenje zabrane o pušenju i br. telefona:
MILICA PUNDUK
065 834 05 42

ARNEG S.P.A.
Odgovorno lice za sprovođenje zabrane o pušenju i br. telefona:
DARKO DRILJAČA
063 808 74 75

APCOM DISTRIBUTION
Odgovorno lice za sprovođenje zabrane o pušenju i br. telefona:
MARKO KOVAČEVIĆ
011 22 00 650

PHOSAGRO BALKANS DOO
Odgovorno lice za sprovođenje zabrane o pušenju i br. telefona:
STEVO JEZDIĆ
065 23 93 111

GEORG MULLER, WALTER KLEIN
Odgovorno lice za sprovođenje zabrane o pušenju i br. telefona:
065 834 05 42

KONSTANTIN VIKTOROVIĆ FILIMONOV
Odgovorno lice za sprovođenje zabrane o pušenju i br. telefona:
065 23 93 111



DIMENZIJE:

210x297mm

MATERIJAL:

Klirir opal beli 3mm

Direktna uv štampa

DIMENZIJE:

210x148.5mm

MATERIJAL:

Klirir opal beli 3mm

Direktna uv štampa

LIFT - LOBI

OZNAKA SPRATA / ULAZA

SPISAK ZAKUPACA - LOBI

TABLA ZAKUPCA - KANCELARIJE

NOSAČ OBAVEŠTENJA

ID KARTICE

ZIDNI SAT





22

DEBLJINA 24mm

VISINA 360mm

MATERIJAL:
CRNA FOLIJA

← A

DEBLJINA 8mm

VISINA 100mm

MATERIJAL:
CRNA FOLIJA



OSNOVA

Lim - mat crni 1.5mm

Direktna štampa na lim + plastifikacija

DIMENZIJE

290x410mm

290mm

410mm

UŠĆE TOWER ONE	
MPC PROPERTIES	Ušće Tower I d.o.o. Beograd
Confluence Property Management doo Beograd	Ušće Shopping Center d.o.o. Beograd
Retail Center d.o.o. Beograd	Gruppo MB d.o.o. Beograd
Balkans Real Estate d.o.o. Beograd	GP Seven d.o.o. Beograd
Bre Development One d.o.o. Beograd	Kalemegdan park d.o.o. Beograd
Stareal d.o.o. Beograd	Immocentar Two d.o.o. Beograd
Sub Real d.o.o. Beograd	Kanem Co d.o.o. Beograd
Tri lista duvana d.o.o. Beograd	Shopping Center IV d.o.o. Beograd
Navigator Business Center d.o.o. Beograd	Ušće Tower Two d.o.o. Beograd
Plaza Prima d.o.o. Beograd	Immocentar I d.o.o. Beograd



MAGNET

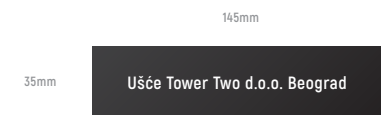

DIMENZIJE

145x35mm

MATERIJAL:

Mat crni klirit 3mm

sa magnetnom podlogom

Direktna štampa na klirit

OSNOVA

Lim - mat crni 1.5mm

Direktna štampa na lim + plastifikacija

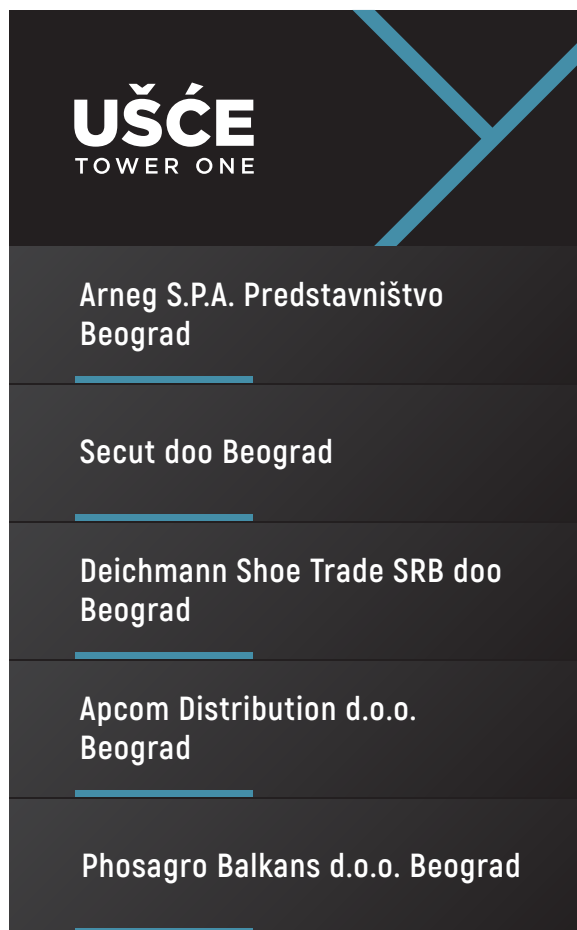

DIMENZIJE

145x235mm

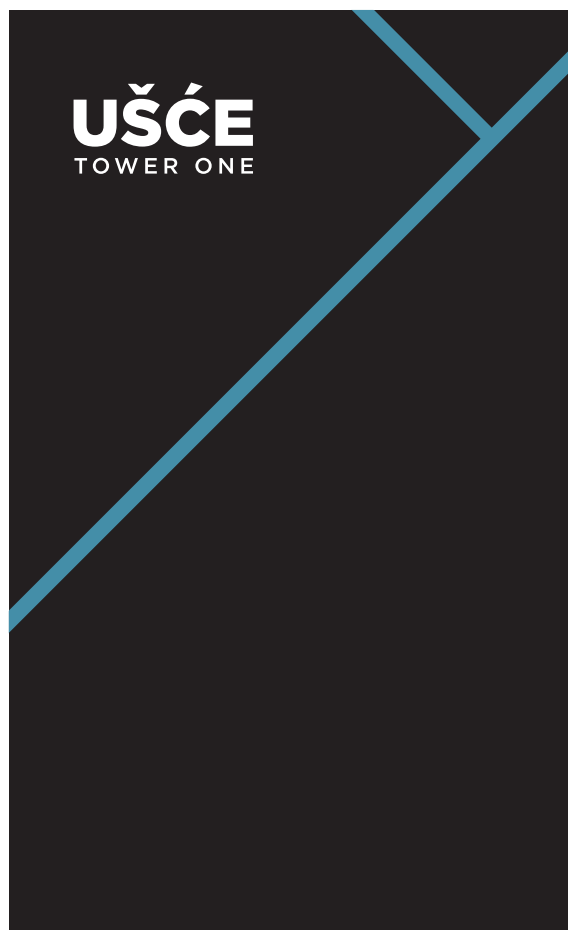

MAGNET

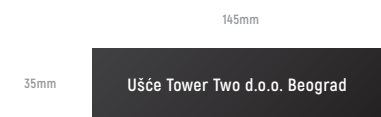

DIMENZIJE

145x35mm

MATERIJAL:

Mat crni klirit 3mm

sa magnetnom podlogom

Direktna štampa na klirit

OSNOVA

Lim - mat crni 1.5mm

Direktna štampa na lim + plastifikacija

DIMENZIJE

145x165mm

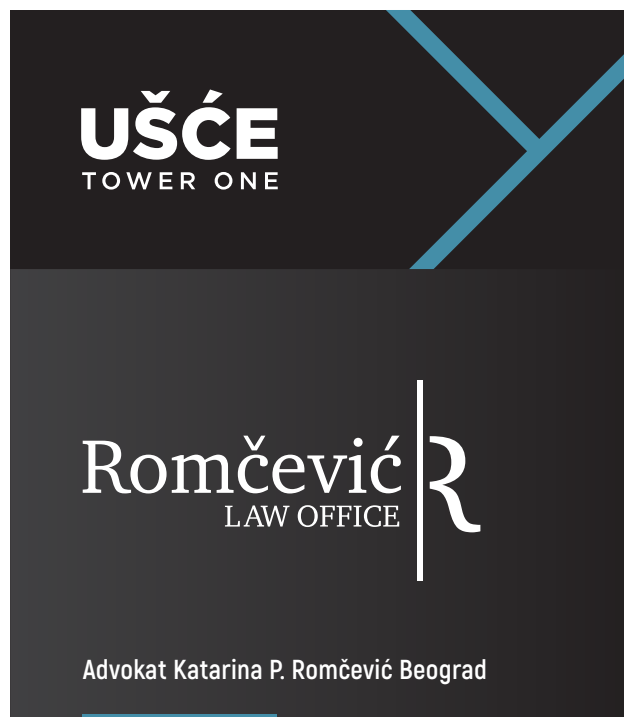

MAGNETI

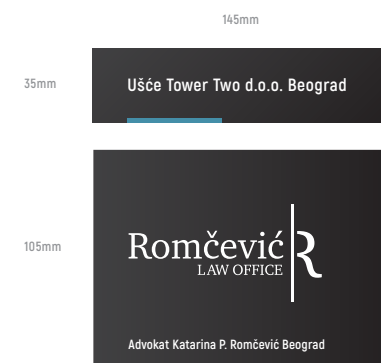

DIMENZIJE

145x35mm

145x105mm

MATERIJAL:

Mat crni klirit 3mm

sa magnetnom podlogom

Direktna štampa na klirit

OSNOVA

Lim - mat crni 1.5mm

Direktna UV štampa

DIMENZIJE

145x130mm

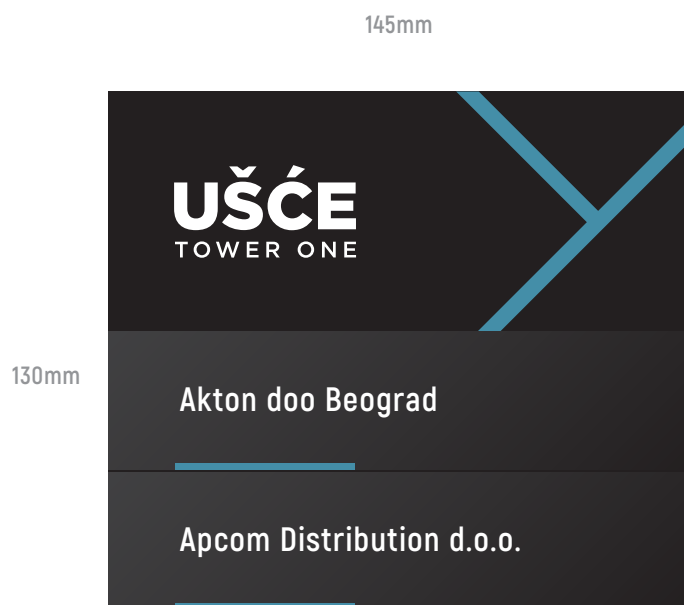

MAGNET

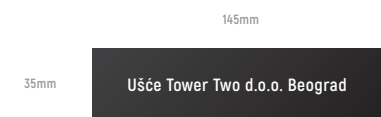

DIMENZIJE

145x35mm

MATERIJAL:

Mat crni klirit 3mm

sa magnetnom podlogom

Direktna štampa na klirit

OSNOVA

Lim - mat crni 1.5mm

Direktna UV štampa

DIMENZIJE

145x165mm

MAGNET

145x105mm

MATERIJAL:

Mat crni klirit 3mm

sa magnetnom podlogom

Direktna štampa UV štampa

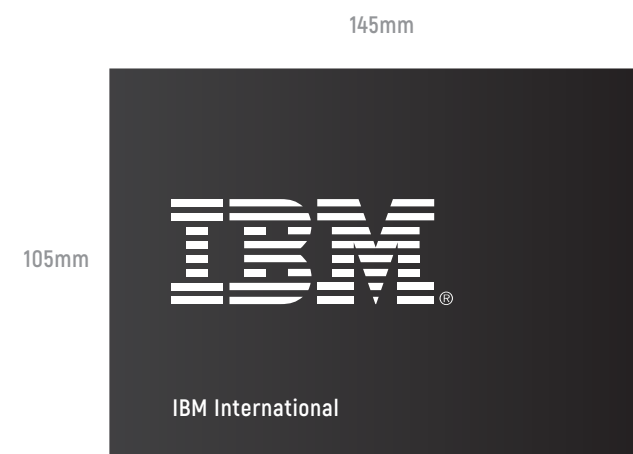
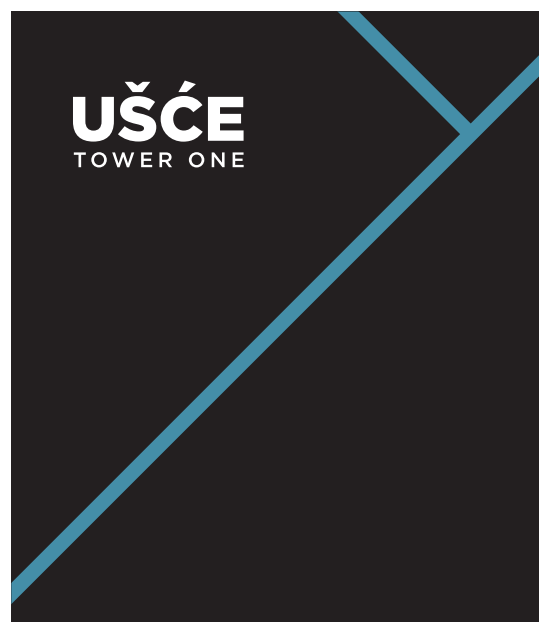

DIMENZIJE:
210mm x 368.5mm

DIMENZIJE:
297.5mm x 260mm

MATERIJAL:
Klirit - mat crni 3mm, direktna UV štampa
Klirit - providni 2mm



LIČNE ID KARTICE

85X54mm - pun kolor obostrano
plastificirane

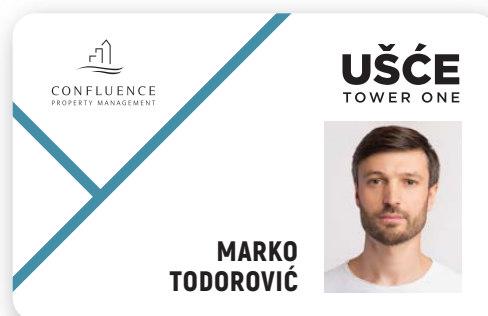

PERSONALIZOVANA I UNIVERZALNA VISITOR KARTICA

85X54mm - pun kolor obostrano
plastificirane



ZAJEDNIČKA POZADINA ZA SVE KARTICE

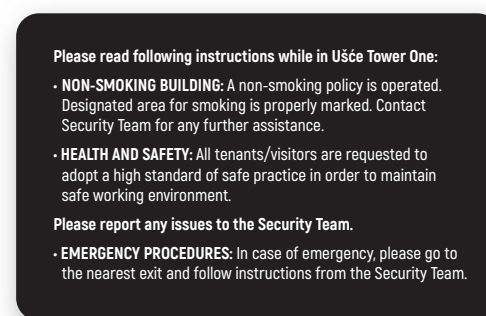

<https://www.bodet-time.com/clocks/led-digital-clocks-indoor/style-5.html>



Optimal reading : 20 m
Height of figures : 5 cm
Dimensions HxW: 106 x 243 mm
Reading angle : 120°
Weight : 0,25 kg



Studio Logoholik
www.logoholik.com